

Deep down,  
 you want Aquatica

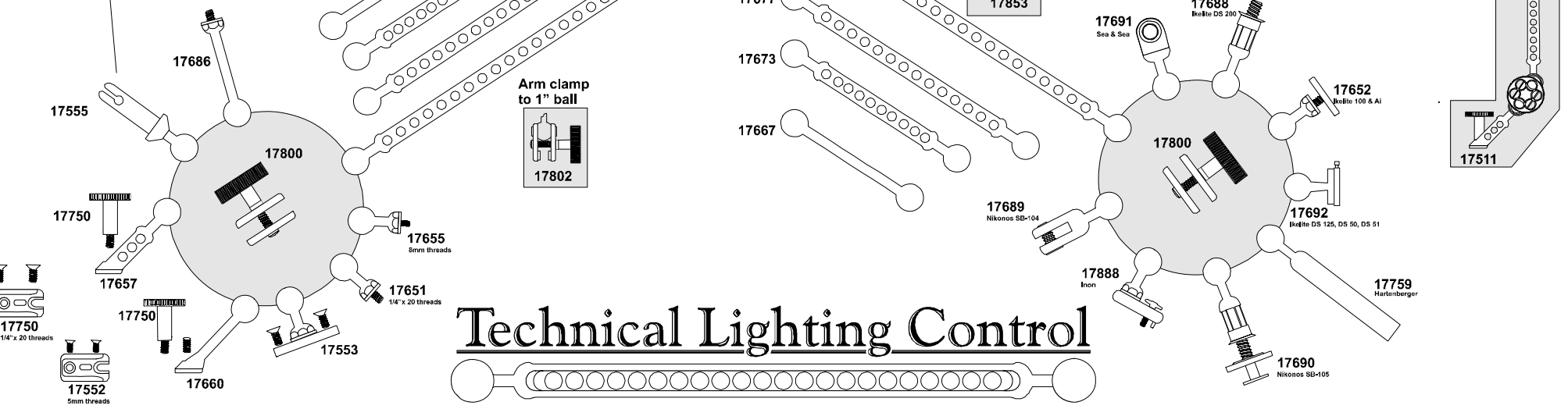
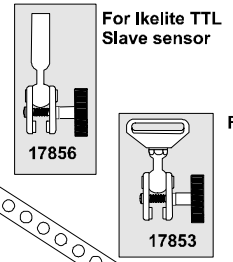
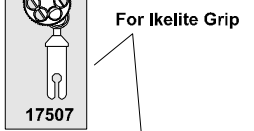
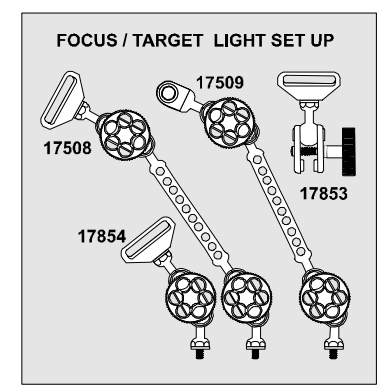
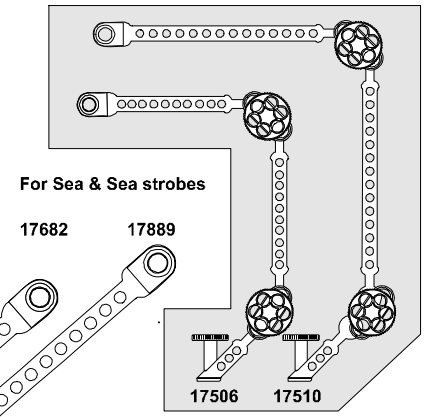
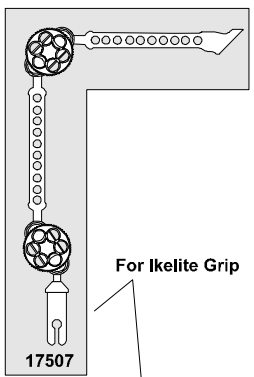
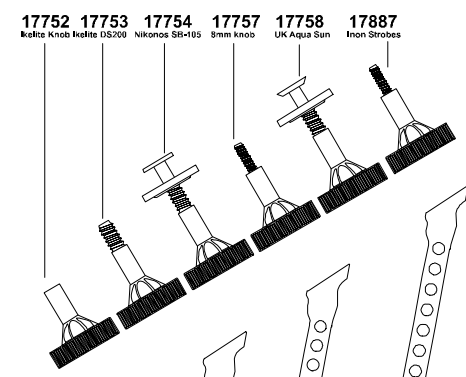
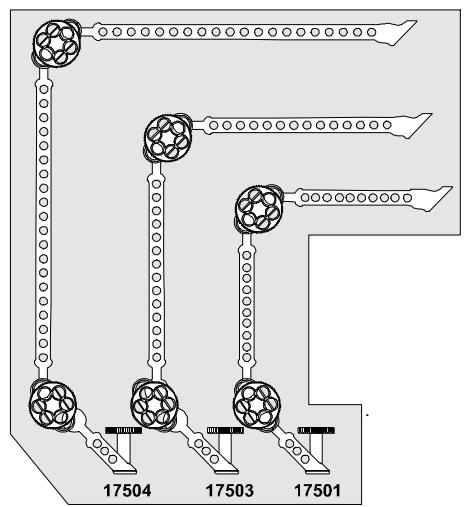

**Technical Lighting Control**

No pins, no O-rings just tough, reliable performance from TLC